

Standard ACCESSORIES

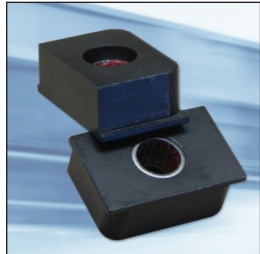

Geared & Beared Nip



Standard Die Block

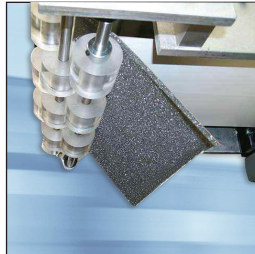

Custom Take-off

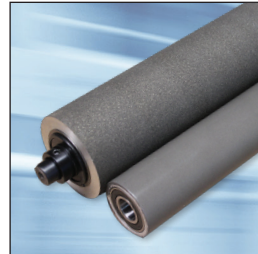

Teflon / Plasma Idlers



Conveyor

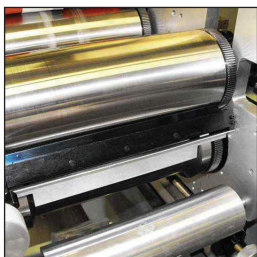

Anvil Scraper

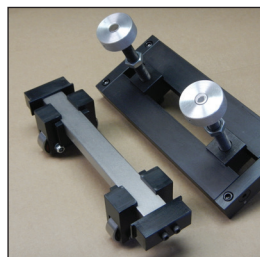

Truck Assembly



Hold Downs



Stripe Guide

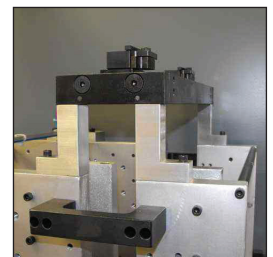

Channel Extenders



Custom Nip & Rollers

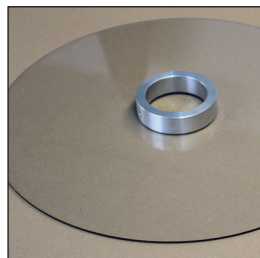

Material Guides

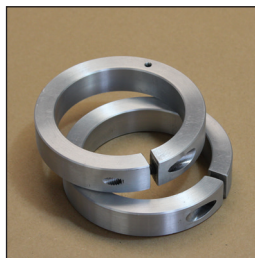

Locking Collars

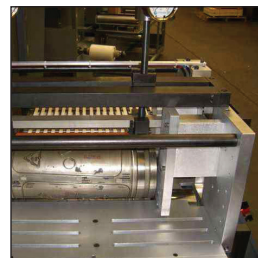

Inner Sideframe

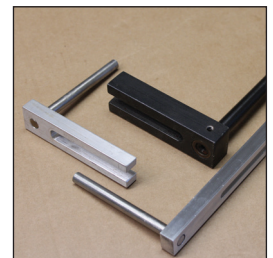

L-Bracket

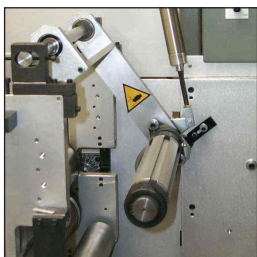

Surface Winder



HydraJacks™

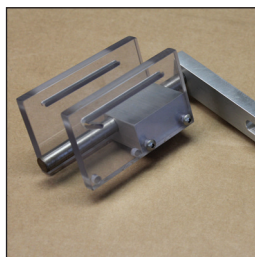

Custom Material Guide



Stepped Adapters

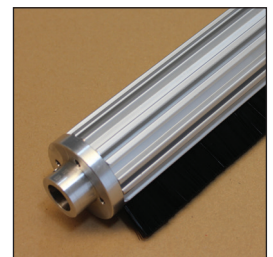

Brush



Rotary Fabrication
Machinery & Accessories



8500 Lake Avenue • Cleveland, OH, 44102
Phone (216) 631-4555 • Fax (216) 631-4555
PACE-Equipment.com

Features & OPTIONS

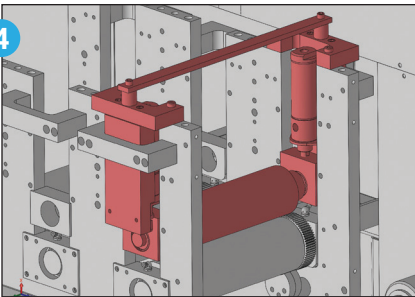
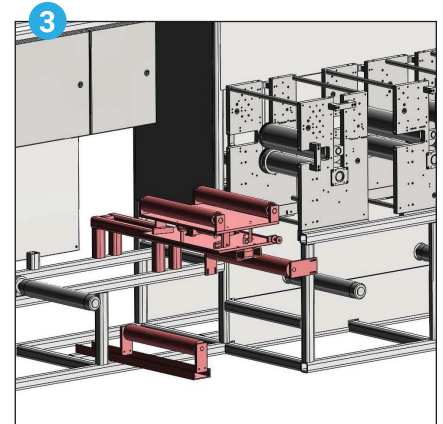

- 1 Light curtains for operator safety
- 2 Predetermining, programmable counter
- 3 Automatic web guidance with splice table
- 4 Pneumatic air nip for ease of operation
- 5 Differential mandrel to wind up multiple rolls while maintaining tension
- 6 Automatic tension control
- 7 Combination brake / clutch units to allow unwinding & rewinding on the same mandrel

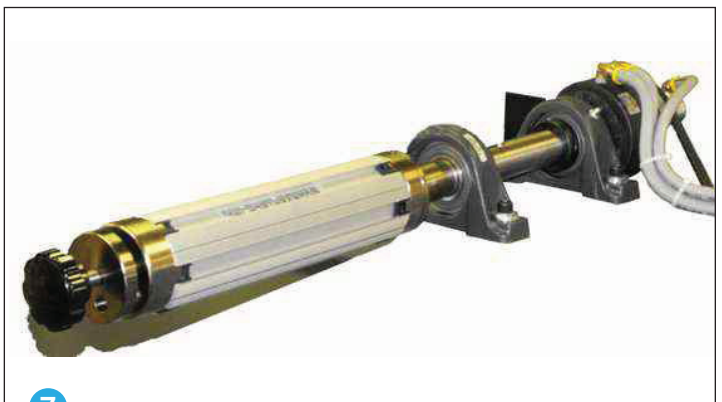

Highest Quality **COMPONENTS**

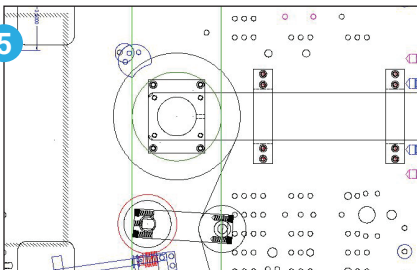
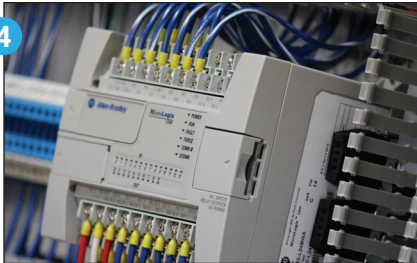
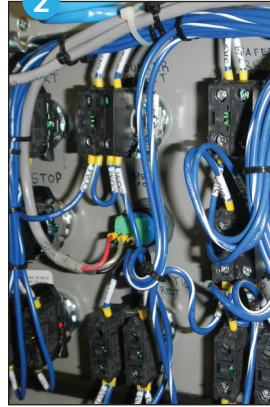

- 1 In-house fabrication and heavy-duty construction
- 2 In-house wiring design and implementation
- 3 VFD AC drive available
- 4 Fully programmable PLC controllers
- 5 Precision engineered to exacting specifications
- 6 Easy to use controls
- 7 Control panels designed to high standards



Rotary Fabrication
Machinery & Accessories



8500 Lake Avenue • Cleveland, OH, 44102
Phone (216) 631-4555 • Fax (216) 631-4555
PACE-Equipment.com

The **PACE** Advantage

PACE has been known as the work-horse brand of the converting industry since 1983. Our rugged construction and customizable machine platform provides the versatility that adds value for our customers. Automotive, aerospace, and medical manufacturers have turned to us with their toughest parts and TRUST PACE, the industry leader for over 30 years.

Rugged Construction

PACE converting machines are built for strength and designed for durability. We use heavy-gauge aluminum plate, stainless steel, thick wall structural tubing, and other top quality materials and components. Our ruggedized construction minimizes maintenance and associated costs over the lifetime of the machine.

Versatility and Flexibility

Our base model machines can process the simplest jobs, or your most complex challenges – our products are built to deliver with precision and performance. All PACE machines are highly configurable, with various options and accessories available to match your specific needs.

Value

PACE machines deliver an ROI unmatched in the converting industry. Our machines are capable of reliable performance for years with an absolute minimum amount of maintenance. With affordable pricing and the fastest payback in the industry, it's no wonder most of our customers own more than one PACE machine.

	Width	Laminate	Diecut	Perforate	Sheet	Removable Anvils	Die Stations	Auto Tension	Auto Web Guide	Auto Registration	Gap Separation	Drive System	Max Speed
Patriot	7"	Yes	Yes	Yes	Yes	No	3	No	No	No	No	Timing Belt	200
DX Basic	10"	Yes	Yes	Yes	Yes	No	3	Available	Available	No	No	Timing Belt	300
DX Expanded	10"	Yes	Yes	Yes	Yes	No	4	Available	Available	No	No	Timing Belt	300
DX Premiere	10"	Yes	Yes	Yes	Yes	Yes	4	Available	Available	No	No	Timing Belt	300
Pacer	7" 10" 12" 13" 14" 16" 18"	Yes	Yes	Yes	Yes	Yes	3-4	Available	Available	Available	Available	Line Drive	300
Big Foot	20"-30"	Yes	Yes	Yes	Yes	Available	3-4	Available	Available	Available	Available	Varies	300
2 Anvil	4"-30"	Yes	Yes	Yes	Yes	Available	2	Available	Available	No	No	Timing Belt	300
Custom	4"-30"	Yes	Yes	Yes	Yes	Available	Varies	Available	Available	Available	Available	Varies	Varies

USA Sales

For states not listed
sales@pace-equipment.com
(216) 631-4555

Northeast Sales

KY, VA, WV, MD, DE, NJ, CT, RI, ME, NH, VT,
MA & Southern parts of OH, PA, NY & IN
Richard Jefferys
rjeff@pace-equipment.com
(513) 300-3718

Western Sales

WA, OR, CA, ID, NV, UT, NM, WY,
CO, ND, SD, MN, IA, WI
Chris Wiedman
chrisw@pace-equipment.com
(719) 547-1221

Southeast Sales

NC, SC, GA, FL, AL, MS, TN
Steve Anderson
stevea@pace-equipment.com
(803) 213-1099

International Sales

Please contact PACE headquarters
sales@pace-equipment.com
(216) 631-4555

Technical Service

Nick Filippelli
support@pace-equipment.com
(216) 631-4555



Rotary Fabrication
Machinery & Accessories

8500 Lake Avenue • Cleveland, OH, 44102
Phone (216) 631-4555 • Fax (216) 631-4555
PACE-Equipment.com